

CS 200 CART

PNEUMATIC UNDERPINNER

Designed for

Bespoke
Framer

Retail
Framer

Medium
Contract Framer

Volume
Contract Framer



CASSESE CARTRIDGE WEDGES

The CS200 CART works with Cassese cartridge wedges

Speed

Moulding capacity

Ease of use

Space required



THE CS200 CART FROM CASSESE

is an air operated underpinner (v-nailer) really easy to use. Its various patented technical features makes it one of the best underpinner on the market.

The CS200 CART can join high and wide mouldings while ensuring a perfect joining quality thanks to the Ultra™ clamps system.

Its new high-quality aluminum sandwich panels and stainless steel facade ensure robustness and longevity of the machine.

The CS200 CART uses Cassese cartridge wedges, recognized today as the best on the market and allowing you to load the machine faster.

MOULDINGS

Width 5 mm - 190 mm

Height 7 mm - 100 mm

DIMENSIONS

Length 589 mm

Width 600 mm

Height 1171 mm

WEIGHT 44 kg

AIR SUPPLY 6 bars

CONSUMPTION 2l/cycle



MADE IN
FRANCE

EXCLUSIVE DISTRIBUTOR IN AUSTRALIA & NEW ZEALAND

Cassese

LARSON · JUHL
AUSTRALIA



High (100mm) and wide (190mm) mouldings

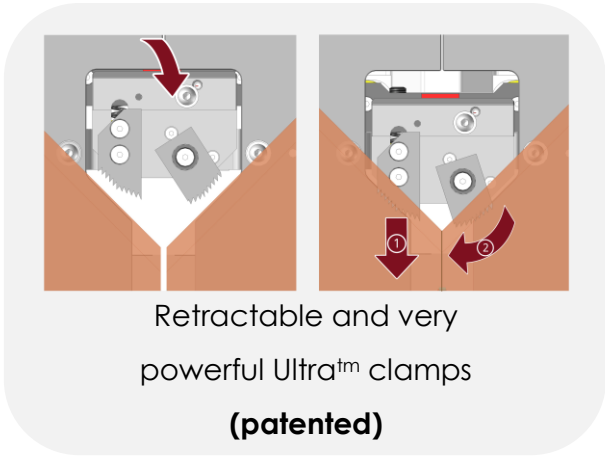

Retractable and very powerful Ultra™ clamps
(patented)



1 : Shoot & stack up wedges
2 : Change of wedge position

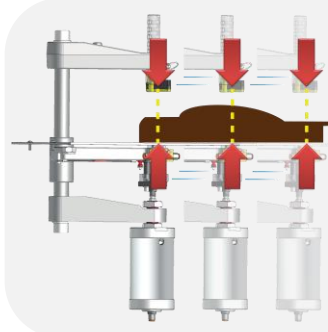

Auto-alignment
No need to adjust top clamp placement

The Smart Wedge Drive System™

Self-adjusting pressure
No need to adjust air pressure between Hardwood and Softwood

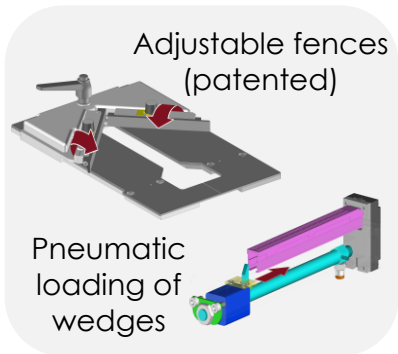
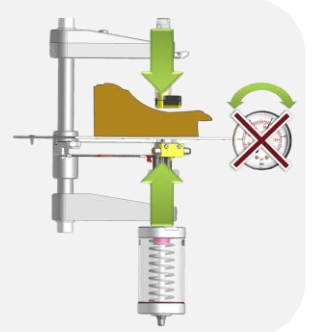

Adjustable fences (patented)

Pneumatic loading of wedges

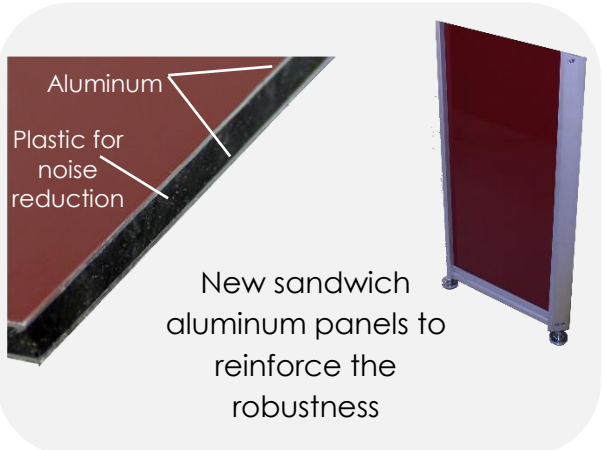

Aluminum
Plastic for noise reduction

New sandwich aluminum panels to reinforce the robustness



Adjustable rod clamp
Magnetic chevron clamp
Solid crossbar

CASSESE CARTRIDGE ARE...



Even stronger (thanks to Power Strip™)

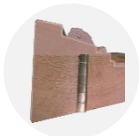

Lubricated = easy stacking

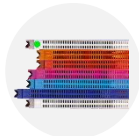

Color coded easy size identification



Glue free = No jammings



Economical



Eco-Friendly (Recyclable Plastic)

INCLUDED ACCESORIES



1 box of 7mm SW
1 box of 10 mm SW
1 box of 10mm HW

